

Hyundai Motor Company
<http://worldwide.hyundai.com>
GEN. LHD 1610 ENG. KM-KM
Copyright © 2016 Hyundai Motor Company. All Rights Reserved.

People's expectation toward individual mobility requires more than just a convenient means of transportation. The old understanding of cars has become outdated. A car represents individuals' lifestyles, and it became an integral part of their lives. At the same time, the automobile industry has experienced seismic change. Hyundai Motor Company has grown rapidly to become one of the largest automakers, backed by world class production capability and superior quality. We have now reached a point where we need a qualitative approach to bring bigger ideas and relevant solutions to our customers. This is an opportunity to move forward and we have developed a new brand slogan that encapsulates our willingness to take a big leap. Led by our new slogan and the new thinking underlying it, we will become a company that keeps challenging itself to unlock new possibilities for people and the planet.



NOW IS MY TIME

The moment I grabbed the steering wheel and felt power kick in at the press of my feet, I knew that this was the start of a new experience.





With a fascinating fresh look, rugged SUV style, dynamic power, and an extraordinary drive, Tucson awakened my senses. I know that this is my time – Tucson will let me be me.



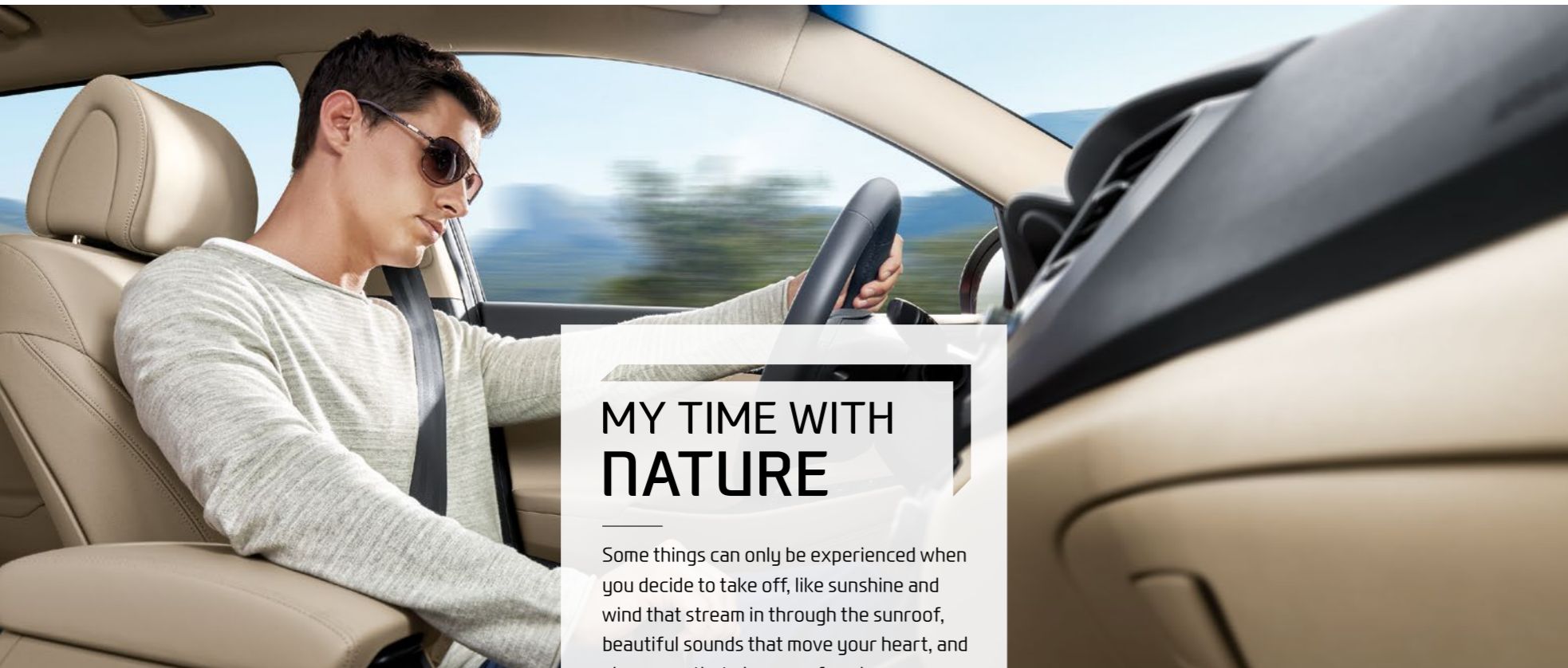

MY TIME WITH NATURE

Some things can only be experienced when you decide to take off, like sunshine and wind that stream in through the sunroof, beautiful sounds that move your heart, and airy space that gives you freedom. Tucson and nature make my time brilliant.





MOMENTS OF SURPRISE

Tucson's attention to details never fails to impress me. I savor every unique experience that it provides.



Panorama sunroof

A functional panorama sunroof enables you to take in the world that surrounds you while stirring your emotions. Bask in warm, natural light during the day and gaze at the stars during the night.

Electric chromic mirror (ECM) and Rear camera display (RCD) system

An Electric chromic mirror (ECM) and Rear camera display (RCD) system provide a rear view of the car through the supervision cluster, revealing blind spots and providing parking assistance.

Audio system (Radio, CD, Bluetooth)

Tucson's audio system produces rich sounds and offers a Bluetooth function that facilitates the playback of music and enables the driver to drive safely while taking calls.



MOMENTS OF TOUCH

My time is filled with comfort as soon as my fingertips come into contact with Tucson's diverse switches. Each switch is optimally placed with my convenience in mind.



DRIVE MODE CONTROL SYSTEM

A button on the center console conveniently offers a choice of 3 driving modes - normal, sports, and eco - to match drivers' mood and driving conditions.

Optimal maneuverability and viewing angle

Diverse buttons are laid out efficiently according to function. The steering wheel is mounted in an optimum position and angle to avoid interrupting the driver's field of vision.

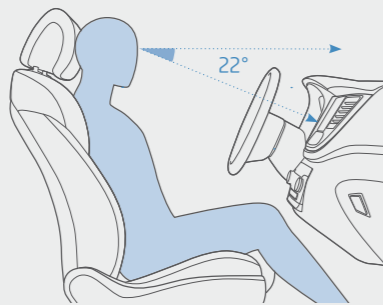

SUPERVISION CLUSTER WITH 4.2" COLOR TFT LCD

The highly visible supervision cluster comes with a color TFT LCD to enable the driver to identify diverse driving information more easily, and the trip computer comes with a remote control on the steering wheel to facilitate its operation.

Exterior lamps outage information

Whenever an exterior lamp circuit is broken, the supervision cluster informs the driver about the location of the broken lamp for added convenience.

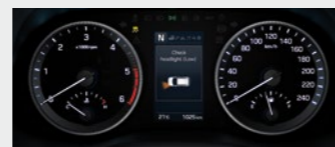

Multifunction switch status indicator

Drivers can easily grasp the current status of multifunction switches (Exterior lights/Wiper control) through the supervision cluster.

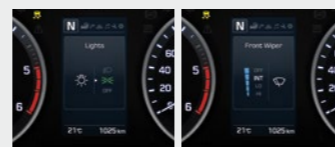

STEERING WHEEL

The steering wheel's spoke was reshaped and the diameter was reduced by 10 mm to improve handling and grip.

1 Cross-cut view

Irregular shape for a tighter grip.

2 Remote control

All switches are grouped within easy reach to enhance comfort and provide better control.

3 Large hand-resting area

The hand-resting area was enlarged to provide greater comfort while driving.

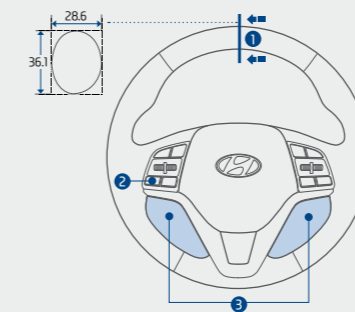

SEAT ADJUSTMENT FUNCTIONS

Ergonomically designed front seats are upholstered in leather to provide a luxurious feel and superior comfort.

Driver's 10-way power seat

Drivers can adjust their seat in 10 different ways to fit their body shape and posture, while 2-step lumbar support provides more solid support for their lower back. The front passenger seat can be adjusted in 8 different ways.



MOMENTS OF TRANSFORMATION

Every time I change the seat and trunk space layout according to my will, my time is filled with newly found enjoyment.



Seat variation

Rear seats can be folded in a 6:4 formation to fit objects of diverse shapes and sizes, while a generous 513-liter cargo space easily accommodates large amounts of luggage. A 1,094 mm-wide opening of the tailgate makes loading and unloading easier.

Smart tailgate system

An innovative smart tailgate system provides added convenience when loading and unloading the vehicle by opening the tailgate automatically when the driver stands near the back of the car for 3 seconds with the smart key.





**MY TIME IN
THE CITY**

The rhythm of the city always excites me. I can feel Tucson's dynamism even when the car is standing still. I am overjoyed by its drivability and safety as it responds to ever-changing road conditions. Tucson and the city add to the excitement of my time.

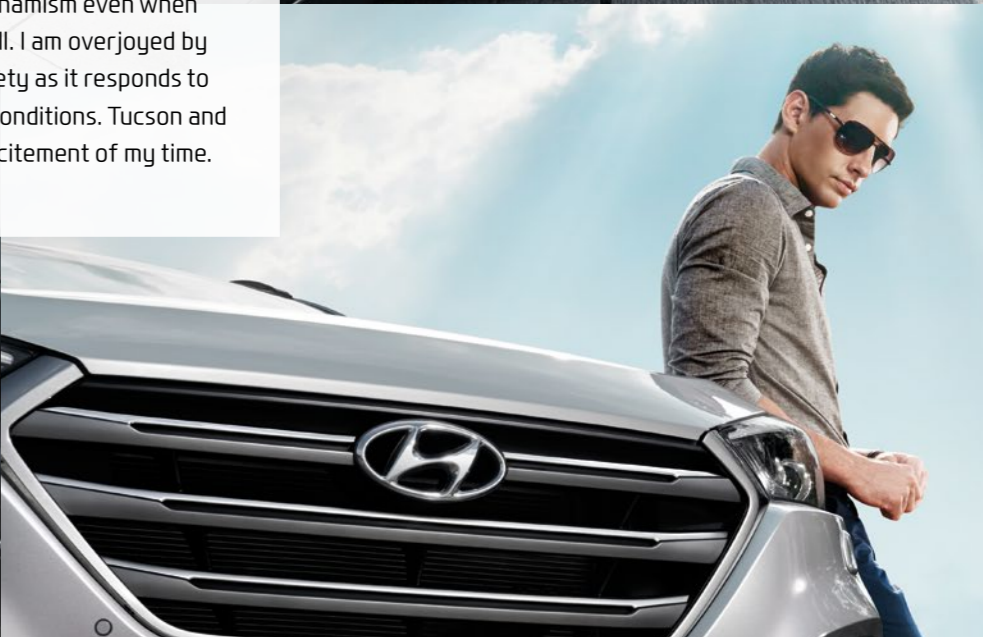





MOMENTS OF CONNECTION

When I feel the true power of an SUV come through Tucson's agile handling yet calm interior, I am filled with passion and stirred with excitement.



7-speed Double clutch transmission (DCT)

7-speed Double clutch transmission (DCT) reduces fuel consumption and CO₂ emissions while improving acceleration compared to conventional auto-transmissions.

6-speed automatic transmission

A smooth, 6-speed automatic transmission is easier to operate than ever before thanks to a newly designed boot-type lever that adds a nifty design touch. It also delivers better acceleration and fuel economy while emitting less CO₂.



1.6 T-GDi gasoline engine

As Hyundai Motor's 1st SUV to offer the choice of a turbo engine, Tucson is able to deliver a more dynamic and powerful driving experience with a turbo GDi gasoline engine that has a maximum output of 177 ps at 5,500 rpm and maximum torque of 27.0 kg-m at 1,500 ~ 4,500 rpm.

* The 1.6 T-GDi gasoline engine comes with 7-speed Double clutch transmission (DCT).

2.0 MPI gasoline engine

Tucson's gasoline engine, with a maximum output of 157 ps at 6,200 rpm and maximum torque of 20.0 kg-m at 4,000 rpm, delivers a dynamic yet quiet performance ideal for an urban SUV.



2.0 CRDi diesel engine

Tucson's diesel engine delivers a powerful performance with maximum output of 178 ps at 4,000 rpm and maximum torque of 41.0 kg-m at 1,750 ~ 2,750 rpm.

* Engine maximum power and maximum torque figures are based on EU-2 standards.

MOMENTS OF RESONANCE

When Tucson reacts to my whims in perfect unison, my heart races and I get immersed in the most intense and passion-filled drive.



ELECTRONIC STABILITY CONTROL (ESC) WITH 4-WHEEL DRIVE ASSISTANCE CONTROL

Electronic stability control (ESC) monitors the position of the vehicle in relation to the turning of the steering wheel to intervene and apply the brakes individually on each wheel to ensure the stability of the vehicle. A full-time, electronic 4-wheel-drive system optimizes driving performance by actively distributing traction between the front and rear wheels according to the road's surface and driving conditions.

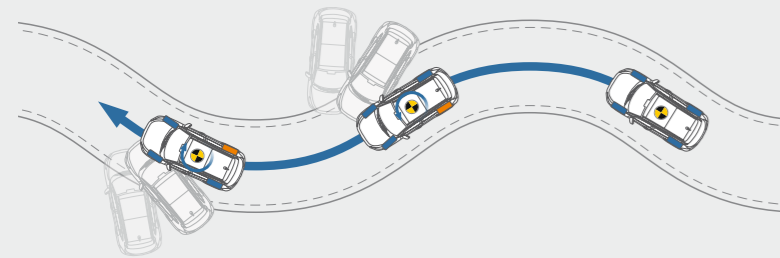

BLIND SPOT DETECTION (BSD)

Sensors prevent collisions by sounding an alarm when they detect vehicles in blind spots or fast-approaching vehicles from the back.

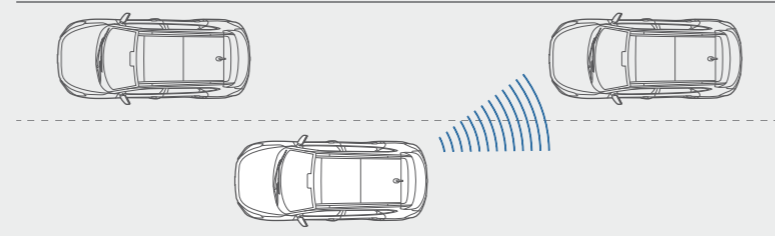

DOWN-HILL BRAKE CONTROL (DBC) AND HILL-START ASSIST CONTROL (HAC)

Tucson can tackle any hill with Down-hill brake control (DBC), which automatically applies a braking force when going down a steep road, and Hill-start assist control (HAC), which prevents the car from rolling back when starting uphill.

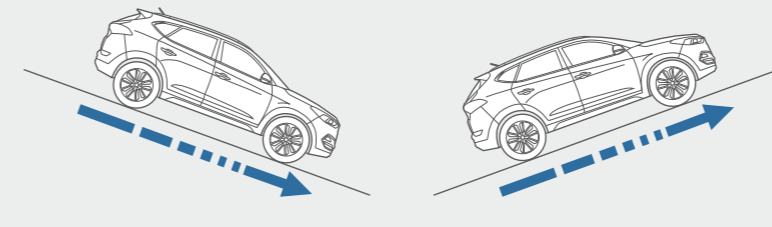

FRONT & REAR PARKING ASSIST SYSTEM (PAS)

Sensors in the front and rear bumpers help to prevent collisions and to park safely by warning the driver about objects that are close by when the vehicle is in reverse.

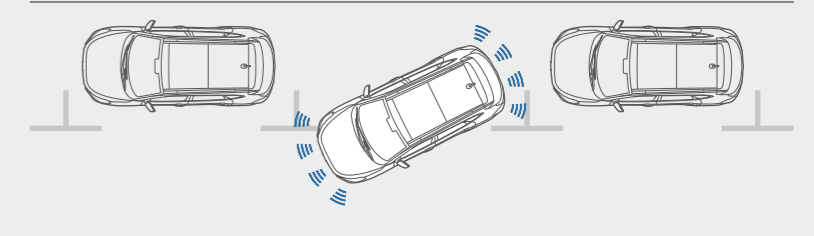

MOMENTS THAT BRUSH BY

When danger, no matter how small, brushes by, Tucson takes charge and ensures my safety before I even know it.



6-airbag system

A driver's airbag, passenger's airbag, 2-side airbags, and curtain airbags protect passengers in the event of a collision.

Advanced high-strength steels (AHSS)

By increasing use of Advanced high-strength steels (AHSS) to 51% of the body and hot stamping the passenger compartment, Tucson offers greater sturdiness and safety. Straightened body connections and installation of load paths improve the vehicle's performance in collision tests, ensuring greater safety in real life situations.





An endless array of incredible moments passes by as I cruise across the city. Now is the time for me to shine.
My Tucson and me - this is my time.

EVERY MOMENT IS BRILLIANT

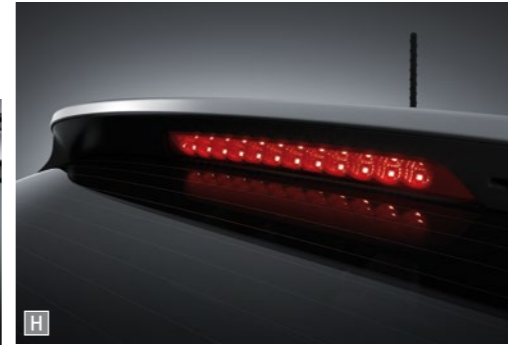

A. LED headlamps

Uniquely shaped LED headlamps complete the vehicle's stylish frontal design while providing illumination of 25W HID headlamps. Static bending lights improve visibility when cornering at night.

B. Chrome-coated outside handles

Chrome handles with an optimized grip highlight the fineness of the vehicle's lateral exterior design.

C. LED Daytime running lights (DRL) & fog lamps

LED Daytime running lights (DRL) remain illuminated during the day while the vehicle is being operated to warn pedestrians and other drivers about the presence of the car. A 3-dimensional front bumper comes with integrated fog lamps that complement the headlamps to improve visibility in bad weather.

D. Radiator grille

Hyundai Motor's iconic hexagonal radiator grille projects a bold and vibrant image while conveying the family look.

E. Outside mirror repeaters & puddle lamps

Outside mirrors were lowered 10 mm to provide better visibility and side repeater lamps were incorporated to project a more solid and sophisticated image. Puddle lamps light up automatically when the vehicle is approached with the smart Key.

F. Power windows

Sensors automatically lower the windows by 150 mm upon detecting a finger or other obstruction in the frame to ensure safety.

G. Dual mufflers

Trapezoidal twin tail trims project a dynamic SUV image while conveying the vehicle's fine quality.

H. Rear spoiler with high-mounted stop lamp

An aerodynamic rear spoiler that enhances Tucson's rugged SUV look improves its driving experience while helping maintain vehicles in the back at a safe distance with a high-mounted stop lamp.

I. LED rear combination lamps

Stylish LED rear combination lamps with a 3-dimensional lighting effect spruce up the vehicle's rear design and improve the car's visibility, promoting safety.

J. 17" steel wheels

K. 17" alloy wheels

L. 18" alloy wheels

EVERY MOMENT IS SPECIAL



A. Heated steering wheel

A steering wheel rim with a built-in heating device provides added comfort in cold weather.

B. Full auto air conditioning system

The full auto air conditioning system with individual controls enables the driver and front passenger to enjoy different temperature levels for their comfort.

C. Power window controls

Ergonomically positioned, driver-side power window adjustment controls ensure ease of operation and maximum control.



D. Engine start/stop button

The engine can be started quickly and easily at the press of a button when the smart key is inside the vehicle.

E. Auto light control

The auto light control senses changes in light intensity surrounding the car and automatically turns the lights on or off. With this function, drivers do not have to operate the switches themselves.



F. Overhead console

Reading lamps, a sunglasses storage case, and a switch for the sunroof are conveniently built-in the overhead console.

G. Reclining rear seats

Rear seat passengers can tilt the seatback to enjoy greater comfort by pulling a lever conveniently placed on the side of the seat cushion.

H. Seat warming & cooling air ventilation

Fans under the front seat cushions pump a gentle stream of cool air to provide exceptional comfort especially in humid weather, while an integrated front seat warmer provides 3 levels of warmth for greater comfort in the winter.



I. Electronic parking brake (EPB)

A state-of-the-art, space-saving switch conveniently activates the parking brake.

J. Connectivity (USB/AUX)

Plug your mobile device into the AUX or USB socket and enjoy your favorite tunes.

K. Glove box (cooling)

Glove box facing the front passenger seat comes with a built-in cooling function to enjoy cold drinks during the summer.

L. Child anchors

Easy mounting feature with locks allows convenient anchoring of child seats to the vehicle in compliance with ISO standards.



INTERIOR TRIMS



Black one-tone



Gray two-tone

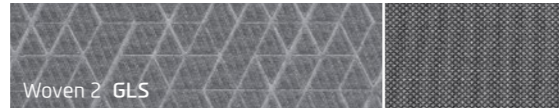
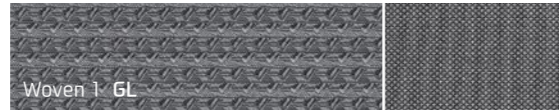

Beige two-tone

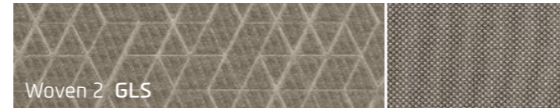

EXTERIOR COLORS

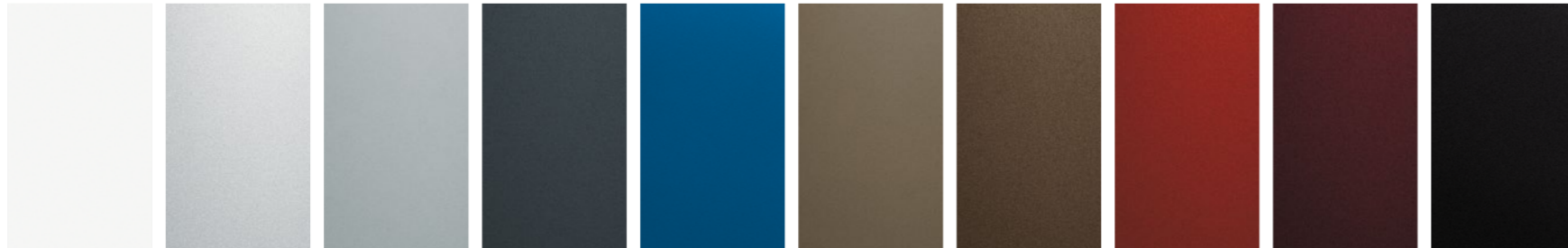

PKW Pure white U5S Platinum silver V65 Galaxy pearl Z5G Pepper gray R5U Ara blue TY5 Milk tea ПП5 Sepia topaz SA5 Sedona orange S5W Ruby wine TCM Phantom black

SPECIFICATIONS

Engine		1.6 T-GDi gasoline engine	2.0 MPI gasoline engine	2.0 CRDi diesel engine			
Type		1.6 T-GDi gasoline engine	2.0 MPI gasoline engine	2.0 CRDi diesel engine			
Displacement (cc)		1,591	1,999	1,995			
Max. power (ps / rpm)		177 / 5,500 (EU-2)	157 / 6,200 (EU-2)	178 / 4,000 (EU-2)			
Max. torque (kg·m / rpm)		27.0 / 1,500 ~ 4,500 (EU-2)	20.0 / 4,000 (EU-2)	41.0 / 1,750 ~ 2,750 (EU-2)			
Suspension							
Type	Front / Rear	McPherson strut type / Multi-link					
Shock absorber	Front / Rear	Strut type (gas) / Shock absorber type (gas)					
Brakes							
General		Dual-diagonal, split-circuit, power-assisted braking system with EBD					
Front brake type	2-wheel drive / 4-wheel drive	Φ305 ventilated disc, floating caliper brakes with pads wear warning device					
Rear brake type	with ABS	Φ302 (2-wheel drive / 4-wheel drive) solid disc, floating caliper brakes with wear warning device / Φ190 (2-wheel drive / 4-wheel drive) high torque parking brake					
ABS		4-wheel electronic, 4-sensor, 4-channel electronic brake distribution, brake torque distribution system (EBD)					
Drive train							
Type		1.6 T-GDi gasoline engine Double clutch transmission (DCT)	2.0 MPI gasoline engine Manual transmission Automatic transmission	2.0 CRDi diesel engine Manual transmission Automatic transmission			
Fuel consumption	CO ₂ level (g/km)	2-wheel drive	-	186 (EU-2)	204 (EU-2)	157 (EU-2)	175 (EU-2)
		4-wheel drive	178 (EU-2)	186 (EU-2)	204 (EU-2)	-	175 (EU-2)
	Combined (l / 100km)	2-wheel drive	-	7.9 (EU-2)	8.6 (EU-2)	5.9 (EU-2)	6.6 (EU-2)
		4-wheel drive	7.5 (EU-2)	7.9 (EU-2)	8.6 (EU-2)	-	6.6 (EU-2)
Tire		225 / 60 R17, 225 / 55 R18					
Fuel tank capacity (liter)		62					
Transmission		7-speed	6-speed		6-speed		
4-wheel drive system		Active on-demand					

- The above values are results from internal testing and could be changed after validation.
- Some of the equipment illustrated or described in this catalog may not be supplied as standard equipment and may be available at extra cost.
- Hyundai Motor Company reserves the right to change specifications and equipment without prior notice.
- The color plates shown may vary slightly from the actual colors due to the limitations of the printing process.
- Please consult your dealer for full information and availability on colors and trims.

DIMENSIONS

Unit : mm

